

Optimization of mechanized soil covering path based on the agronomic mode of full-film double-ditch with double-width filming

Fei Dai¹, Wenjuan Guo^{1,2}, Xuefeng Song¹, Yang Zhang¹, Ruijie Shi¹, Feng Wang¹, Wuyun Zhao^{1*}

(1. College of Mechanical and Electrical Engineering, Gansu Agricultural University, Lanzhou 730070, China;

2. School of Cyber Security, Gansu University of Political Science and Law, Lanzhou 730070, China)

Abstract: In order to further improve the working performance and efficiency of mechanized tillage operation of a full-film double-ditch seedbed, under the working conditions of different parameters of the spiral push-type soil covering device with double-width filming, the dynamic soil covering characteristics and soil covering uniformity of the device were analyzed, the collaborative and interactive coupling mechanism of the horizontal pushing process of the mulching soil and horizontally two-way spiral soil transmission device were revealed, and the main reasons for the influence of different soil covering belts on the change of soil particle number distribution were analyzed. Based on the full-film double-ditch mode with double-width filming, the mechanized soil covering path was optimized. In order to further reduce the disturbance on mulching soil by two-way spiral pushing, a kind of parallel shunt type soil covering device with double-width filming was designed, then a discrete element method was adopted to make simulation analysis and optimize the parallel shunt type soil covering device with double-width filming. Field verification tests showed that after the operation of the full-film double-ditch combined machine with double-width filming and soil covering installed with the parallel shunt type soil covering device, the qualified rate of the film edge soil covering width was 96.1%, an increase of 1.6% compared to that before optimization; the qualified rate of soil covering width at the center of the big ridge was 93.5%, an increase of 1.9% compared to that before optimization; the qualified rate of the soil covering thickness was 97.7%, an increase of 0.2% compared to that before optimization. The test indicators reached the requirements of relevant national and industrial standards, showing that the test results met the design requirements, and the working conditions of verification tests were consistent with the simulation results.

Keywords: full-film double-ditch, double-width filming, soil covering, soil covering path optimization, soil covering device

DOI: 10.25165/j.ijabe.20221501.6853

Citation: Dai F, Guo W J, Song X F, Zhang Y, Shi R J, Wang F, Zhao W Y. Optimization of mechanized soil covering path based on the agronomic mode of full-film double-ditch with double-width filming. *Int J Agric & Biol Eng*, 2022; 15(1): 139–146.

1 Introduction

The level of agronomic requirements in film-mulched seedbed determines the ridge forming, configuration and structure of the film-mulching and soil covering machine and its structural complexity. The soil covering quality is the key factor that determines the film mulching operation^[1-3]. In recent years, the agronomic technology of full-film double-ditch seeding in rain feed regions in Northwestern China has been extensively promoted. Using the existing mechanized construction mode of film mulching seedbeds, it has relatively high requirements for the regularity of the operating conditions, the performance of the supporting equipment and the level of agricultural machinery operation,

especially for the docking soil of the film edge of the large ridge body. In order to alleviate the problems in the mechanized construction mode for a full-film double-ditch film-mulched seedbed, and improve the mechanized operation effect for full-film double-ditch, the agronomic mode of mechanized double-width filming and soil covering was attempted and the supporting equipment was explored^[4].

At present, related film-mulching and soil covering machinery in China and abroad mainly serve greenhouse and facility agriculture to plant vegetables and economic crops. In order to suppress weed growth and make way for the planting mechanism, flat film-mulching and tiny ridge film-mulching were mainly adopted in seedbed mulching. The film surface of the seedbed is flat and there is no interlacing of furrows and ridges; the strength in covering film is high, and the mechanical damage during film laying is small, requiring a simple structure of the combined machine on film-covering seedbed. Generally speaking, the machinery is mainly composed of soil flattening plate or field strip surface shaping device, film spreading roller, shoe-type soil covering shovel and soil covering disc. In China, studies on ridge forming, film-mulching and soil covering machinery system are mainly focused on semi-film soil covering mode, film-mulching and planting combined machine, and the ridge forming mechanism of film laying machine is mainly composed of soil touching parts like rotary blade group (rotary type), ridge forming and ditching shovel, ridge forming and ditching disk (tilted type), as well as

Received date: 2021-06-22 **Accepted date:** 2021-11-08

Biographies: Fei Dai, PhD, Associate Professor, research interest: design of agricultural mechanization equipment, Email: daifei@gsau.edu.cn; Wenjuan Guo, PhD candidate, research interest: computer simulation, Email: 565105996@qq.com; Xuefeng Song, Lecturer, research interest: agricultural mechanization engineering, Email: 549349477@qq.com; Yang Zhang, Lecturer, research interest: agricultural mechanization, Email: zy3537@qq.com; Ruijie Shi, PhD candidate, research interest: agricultural mechanization engineering, Email: 1139230110@qq.com; Feng Wang, Master candidate, research interest: agricultural mechanization engineering, Email: 452950191@qq.com.

***Corresponding author:** Wuyun Zhao, PhD, Professor, research interest: farm machine and mechanical reliability. College of Mechanical and Electrical Engineering, Gansu Agricultural University, Lanzhou 730070, China. Tel: +86-451-7632472, Email: zhaowu@gsau.edu.cn.

supporting ridge reshaping mechanisms. The film-mulching mechanism mainly adopts passive film spreading rollers, however, due to different structures of soil covering mechanisms, it can finish soil covering with the help of supporting soil covering discs or soil covering shovels. Among them, Niu et al.^[5,6] studied and developed a series of cotton and rice seeder for synchronous film-mulching and pipe-laying, and designed a double soil covering cylinder-roller mechanism with inner helical soil covering cylinder and double-film covered crossed soil casting, which can realize the function of covering soil strips. The two soil covering mechanisms above are reliable and have been applied in the soil covering and planting equipment in China. Zhao et al.^[7] and Lü et al.^[8] also reported the soil covering mechanism in their studies on peanut film-mulching seeder and covering device for membrane seedling. In order to improve the quality of key links in soil covering in the rice film-mulching dry direct seeding, Zhao et al.^[9] designed a kind of helical soil covering device that can cover holes, and analyzed and discussed the influence law of its structure parameters on soil covering quality. In order to shorten soil transport path and ensure timely soil unloading, Li et al.^[10] and Cui et al.^[11] designed a kind of soil covering device with tilted soil delivery belt and chute, which could realize covering of soil belts. The device changed side soil fetching into soil lifting and delivery before the film. In order to eliminate wheel tracking in paddy fields and construct a good environment for planting machinery, Yang et al.^[12] proposed a kind of helical soil covering device with an equal diameter and variable pitch, which realized symmetrical and uniform soil delivery and covering, and ensured the flatness of the seedbed. However, the soil covering devices mentioned above adopted the method of soil fetching beside film. Since it is required that there should be uncovered soil belts between mulched film in the whole plot of farmland, to let the soil covering mechanism fetch soil continuously and walk ahead, such devices cannot meet the agronomic requirements of seeding technology on full-film double-ditch seedbed.

Based on the agronomic mode of full-film double-ditch seedbed with double-width filming, improving the level of mechanization construction performance and efficiency of seedbed, in this study, a kind of spiral push-type soil covering device on the full-film double-ditch seedbed was designed. After simulation on the dynamic operation process of “soil lifting-soil delivery-soil covering” by the device by applying the discrete element method and field verification tests, results showed that the device could basically satisfy the double-width filming requirements for full-film double-ditch seedbed^[4]. In order to improve the quality of mechanized soil covering under the double-width filming mode, the soil delivery and covering characteristics and problems in each link of the spiral push-type double-width filming and soil covering device on full-film double-ditch seedbed were further analyzed, the key factors that affect the soil covering performance were explored, the mechanized soil covering path was optimized, to improve the double-width filming soil covering device on double-width filming seedbed.

2 Structure and working principles

2.1 Structure

The spiral push-type soil covering device on a full-film double-ditch seedbed with double-width filming is mainly composed of a scrapper soil lifter, a two-way spiral soil delivery mechanism, a V-type chute soil covering mechanism, enclosures and a traditional system, and its structure is shown in Figure 1^[4].

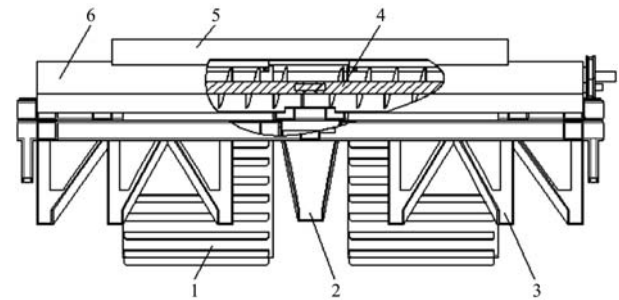

1. Scrapper soil lifter 2. Central chute 3. Side chute 4. Two-way spiral soil delivery device 5. Soil lifting enclosure 6. Soil delivery enclosure

Figure 1 Structure diagram of the spiral push-type soil covering device with double-width filming

2.2 Working principle

According to the agronomic technology cultivation mode of full-film double-ditch seedbed with double-width filming, the operation process of the spiral push-type soil covering device with double-width filming is shown in Figure 2^[4]. The soil covering path is: in high-speed rotary tillage, the covering soil is cast backward, and through the tilted elevation of soil by the two sets of scrapper soil lifters, the soil is delivered into the horizontally two-way spiral soil delivery device. Through pushing by the two-way spiral blades, the soil is discharged from five soil outlets. Then guided by the seven sets of chutes, the soil is guided and formed into seven soil belts, including a soil belt on the center of the big ridge, four soil belts on the ditches and two soil belts on film edges. Among them, the four soil belts on ditches are covered by the shunting of the soil particles through the mode of “one soil outlet to two chutes”.

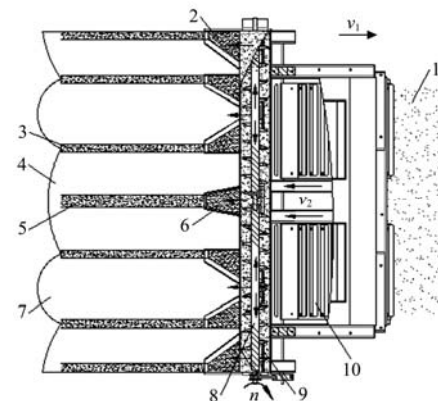

1. Filed soil 2. Side chute 3. Soil belt on ditch 4. Big ridge 5. Central soil belt on big ridge 6. Central chute 7. Small ridge 8. Horizontal two-way spiral soil delivery device 9. Chute 10. Scrapper soil lifter

Note: v_1 : Forward speed of operation machine; v_2 : Lifting linear velocity of scrapper soil lifter; n : Rotate speed of horizontal two-way spiral soil delivery device.

Figure 2 Operation process diagram of the spiral push-type soil covering device with double-width filming

3 Soil covering characteristics of the spiral push-type soil covering device with double-width filming

3.1 Soil covering characteristics of the device under different working parameters

In order to further analyze the spiral push-type soil covering characteristics with double-width filming, and check the effect of the soil covering operations under different working parameters, the related simulation parameters of the established discrete element model, structural parameters and particle factory settings can be found in References [13-15]. The simulation time step was 1.405×10^{-5} s, which is 40% of the Rayleigh time step, and the

simulation was performed for a total of 2.5 s. Based on the operation speed alternation of the scrapper soil lifter and horizontal two-way spiral soil delivery device between fast, slow and moderate speed, and according to previous research mode and test results, the scrapper soil lifter is controlled by the coupling server panel in the EDEM software through dynamic coupling. Then a linear rotary movement was added to the horizontal two-way spiral soil delivery device in the Geometry panel. According to

Reference [4], $v_2=1.10$ m/s and $n=110$ r/min was calculated respectively, so the linear velocity v_2 of the scraper soil lifter and the rotation speed n of the horizontal two-way spiral soil delivery device were set to ($v_2=0.90$ m/s, $n=130$ r/min), ($v_2=1.10$ m/s, $n=110$ r/min) and ($v_2=1.30$ m/s, $n=90$ r/min), respectively. By setting three types of different working parameters, the dynamic operation process of the spiral push-type soil covering device with double-width filming is shown in Figure 3.

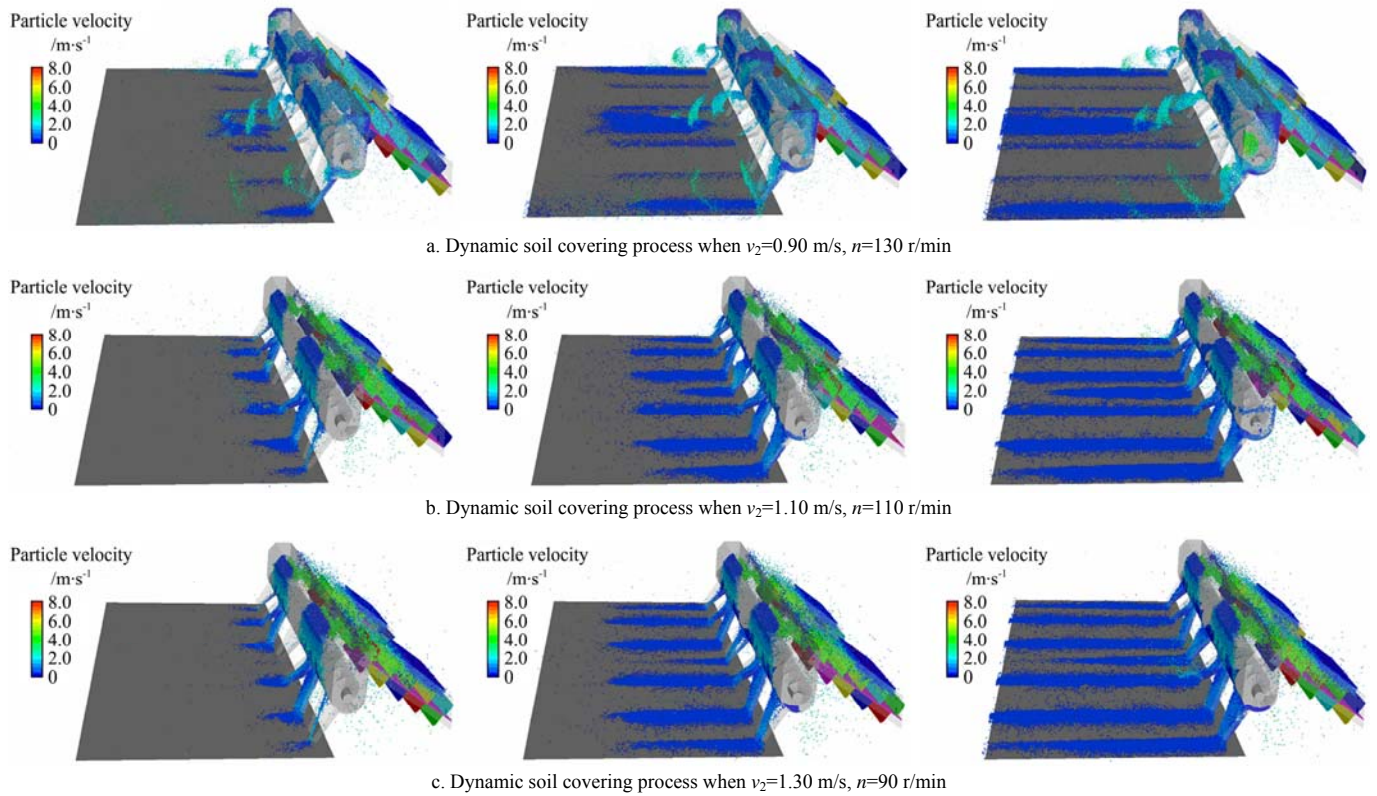

Figure 3 Dynamic soil covering characteristics of the spiral push-type soil covering device with double-width filming

As shown in Figure 3, by setting the different linear velocities of the scraper soil lifter and different rotation speeds of the two-way rotary soil delivery device in coordinated soil covering operation, the instantaneous soil covering characteristics of the push-type soil covering device with double-width filming can be displayed. When the linear speed of the scraper soil lifter is low, and the rotating speed of the horizontal two-way spiral soil delivery device is fast (Figure 3a), and the mulching soil would splash. The reason is that, when the linear velocity of the scraper soil lifter in lifting the soil is too low, the amount of soil entering into the soil delivery enclosure is relatively small, also, with the fast axial rotation and pushing by the horizontal two-way spiral soil delivery device, the central soil belt on the big ridge and the film edge soil belts are quickly formed. The four soil belts on the four ditches are not uniformly laid due to the short path of the soil particles. On the contrary, due to the fast rotation and pushing by the horizontal two-way spiral soil delivery device and the resulting

high rotary inertia, soil delivery is not continuous and the soil belts are not uniform (Figure 4a). At the same time, compared with the soil covering characteristics in Figures 3b and 3c, when the speed of the scraper soil lifter is fast, it can ensure enough mulching soil to enter the soil delivery enclosure. Regardless of the rotation speed of the horizontal two-way spiral soil delivery device, the seven soil belts can basically meet the agronomic requirements on the seedbed with full-film double-ditch seedbed with double-width filming (Figures 4b and 4c). However, when the rotation speed of the horizontal two-way spiral soil delivery device is low, the long axial pushing path restricts the mulching soil on the central soil belt on the big ridge, making the variable coefficient of the seedbed soil covering thickness and width unstable (Figure 4c), bringing difficulties to the effective suppression of the subsequent soil belts. The uniformity of soil covering by the spiral push-type soil covering device with double-width filming under different working parameters is shown by the red lines of the soil belts in Figure 4.

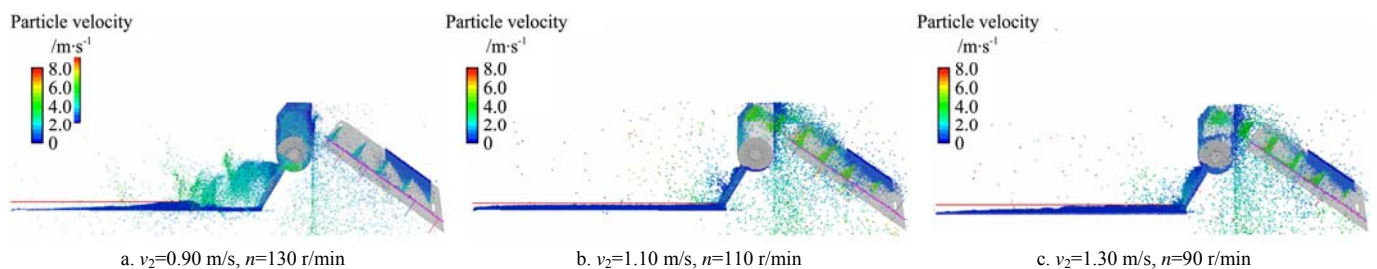
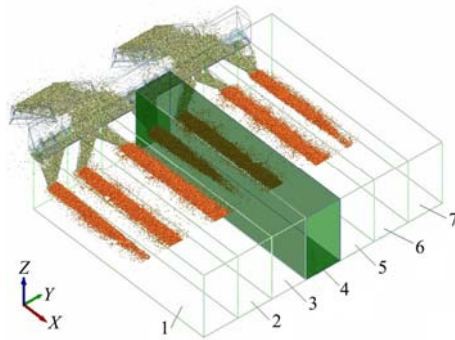

Figure 4 Soil covering uniformity of the spiral push-type soil covering device with double-width filming

3.2 The number distribution of soil particles in different soil belts

As shown in Figure 5, from the near to the far side of the axis are the central soil belt on big ridge (No. 4), four soil belts on ditches (No. 2, No. 3, No. 5, and No. 6) and two film edge soil belts (No. 1, No. 7) respectively. According to the different working parameters shown in Figure 4, statistical analysis was carried out on the distribution of the number of soil particles in different soil belts of the spiral push-type soil covering device on full-film double-ditch seedbed with double-width filming under three working conditions.



1. Film edge soil belts 2. Soil belts on ditches 3. Soil belts on ditches 4. Central soil belt on big ridge 5. Soil belts on ditches 6. Soil belts on ditches 7. Film edge soil belts

Figure 5 The number distribution of soil particles in different soil belts

With the different working parameters of the scrapper soil lifter in tilted elevation of soil and horizontal two-way spiral soil delivery device, the collaborative and interactive coupling process in pushing soil horizontally was realized. The different soil belts with the corresponding number distribution of soil particles are shown in Figure 6.

It can be seen from the curve of the simulation test that the distribution trend of the number of particles in the different belts in Figure 6a is quite different from that under the other two working conditions. Among them, in Figure 6a, the number of soil particles in the central soil belt (No. 4) of the big ridge is about 34 000 to 35 000, which is significantly higher than that in other soil belts. The reason is the rapid horizontal axial pushing of the soil on the scrapper soil lifter during the rapid rotation of the horizontal two-way spiral soil delivery device, causing the interaction of soil inertia force from both sides at the central soil outlet, therefore, the mulching soil instantly falls under the effect of gravity. At the same time, the chutes corresponding to the soil belts on ditches (No. 2 and No. 3) and (No. 5, No. 6) are also pushed to both sides due to the rapid rotation of the horizontal two-way spiral soil delivery device. Therefore, it can be seen from the curve of the simulation test in Figure 6a that, the number of soil particles is about 3000 to 9000, which is small on the four soil belts on the ditches, but they have a basically consistent variation tendency. When the remaining soil is further pushed to both sides of the soil delivery enclosure, it would gradually retain in the enclosure. The rapidly rotating blades in the soil covering device stir and disturb this part of the soil, and discharge the soil from the soil outlets corresponding to the film edge soil belts (No. 1, No. 7). The number of particles in the film edge soil belts is about 15 000 to 17 000, that is between that in the central soil belt of the big ridge and that on ditches. In addition, it can be seen by comparing Figures 6b and 6c that the numbers of soil particles in

different soil belts are different under the two working conditions. The reason is the slow rotation speed of the horizontal two-way spiral soil delivery device, which cannot deliver the soil transported by the scrapper soil lifter to the central soil outlet and film edge soil outlets, which are relatively farther. Therefore, the number of soil particles in the central soil belt on the big ridge (No. 4) in Figure 6b is significantly higher than that (No. 4) in Figure 6c, but the overall curve distribution tendencies in the two figures are basically consistent.

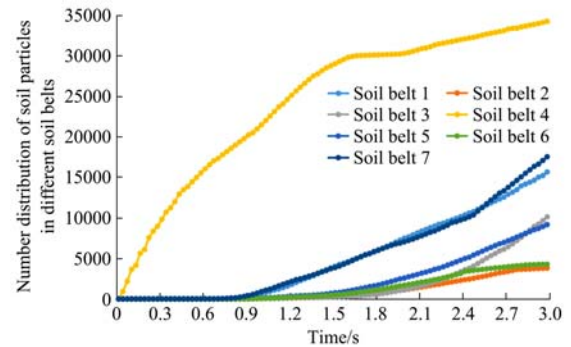

a. $v_2=0.90$ m/s, $n=130$ r/min

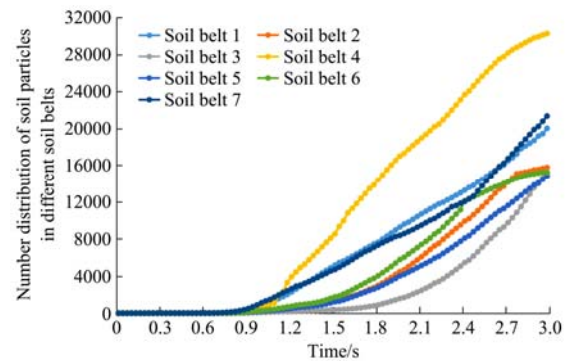

b. $v_2=1.10$ m/s, $n=110$ r/min

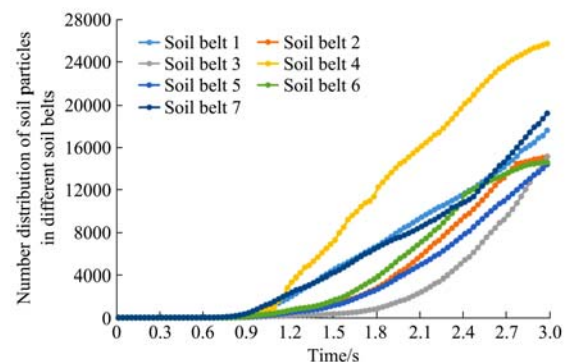

c. $v_2=1.30$ m/s, $n=90$ r/min

Figure 6 The number distribution of soil particles in different soil belts

3.3 Analysis of existing problems and control strategy

It can be known through the soil covering characteristics under different working conditions and soil particle number distribution in different soil belts of the device that, the appropriate linear velocity of the scrapper soil lifter can ensure to lift sufficient soil to the soil covering enclosure, however, since the axial rotary pushing path for the horizontal two-way spiral soil delivery device is too long, different segments of the path with different rotating directions would disturb soil pushing, and the high rotary inertia is the main cause of soil particle splash and bounce in the operation process, especially at the central soil outlet and the film edge soil outlet. Figure 7 shows the working

condition of soil delivery at the film side and central soil outlet of the spiral soil delivery device when it is horizontally pushing the soil at different rotation speeds.

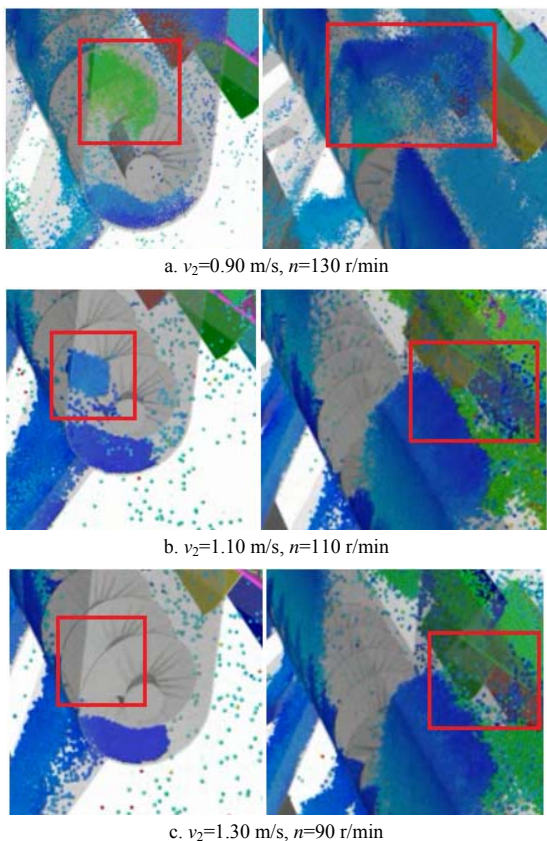

Note: Red boxes show the dynamic change of soil covered with film under different working parameters.

Figure 7 Disturbance on mulching soil by the horizontal two-way spiral soil delivery device

From the numerical simulation process, it can be seen that the horizontal two-way spiral soil conveying device is the key component connecting the scrapper soil lifter and the chutes, which can ensure the fast pushing of the lifted soil in the horizontal axial direction. However, the faster the speed is, the more the soil is disturbed, reducing the effective daylighting area of the mulched seedbed, and is not conducive to the attachment and fixation of the mulching film, finally causing failure in constructing the mechanized seedbed. Therefore, it is necessary to optimize the mechanized soil covering path under the agronomic mode of full-film double-ditch with double-width filming. For example, to cast soil to a longer distance, so that it can quickly enter each chute under gravity to complete the soil covering. It is a good attempt to optimize the soil covering path by replacing the operation of the horizontal two-way spiral soil delivery device.

4 Optimization of mechanized soil covering path

4.1 Improvement and optimization of soil covering path

The optimized parallel shunt type soil covering device with double-width filming is mainly composed of a scrapper soil lifter, soil covering enclosures, chutes of the ditches and central chute of the big ridge, as shown in Figure 8.

In order to further optimize the mechanized soil covering path and replace the pushing effect of the horizontal two-way spiral soil delivery device, the scrapper soil lifter was used to cast soil in a tangent line in the soil covering enclosure, then the soil would fall into the corresponding chutes based on its gravity. Among them,

in order to ensure that the soil entering the ditch chutes and big ridge chute is uniform and stable, considering the “principle of parallel shunt of particles”, a soil outlet was set in the central chute. According to the agronomic requirements on mulching soil amount, part of the soil entering the big ridge chute was diverted to the chutes of the ditches, and the connection of all chutes realizes the laying of big ridge soil belt. The parallel shunt type operation process is shown in Figure 9.

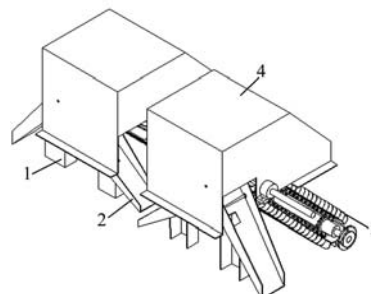

1. Ditch chute 2. Big ridge chute 3. Scrapper soil lifter 4. Soil covering enclosure

Figure 8 Structure diagram of the parallel shunt type soil covering device with double-width filming

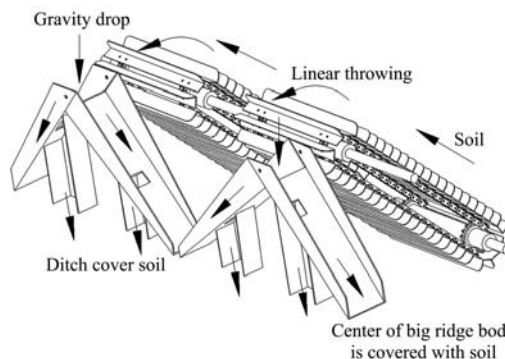

Figure 9 Parallel shunt type operation process of the mulching soil

Existing studies have shown that the mulching soil on small ditches is 1.30 kg^[4,16], and the amount of mulching soil at one side of the big ridge is 3.25 kg. Therefore, according to the ratio of the amount of soil by parallel shunt, the ratio of the area of the soil outlet to the area of the central chute of the big ridge can be calculated by Equation (1) as follows:

$$k = \frac{Q_1}{Q_2} \times 100\% \tag{1}$$

where, Q_1 is the amount of soil covering the ditches, kg; Q_2 is the amount of soil covering one side of the big ridge, kg; k is the ratio of the area of the soil outlet to the area of the central chute of the big ridge.

The calculation results show that the ratio of the area of the soil outlet to the area of the central chute of the big ridge is 28.6%.

4.2 Simulation analysis of the operation process of the parallel shunt type soil covering device with double-width filming

In order to optimize and improve the working performance of the parallel shunt type soil covering device with double-width filming, a discrete element method was adopted to do simulation analysis on the soil covering process (Figure 10), and the parameter setting of the established model is the same as that in Section 2.1 of this study. The simulation time step was 1.405×10^{-5} s, which is 40% of the Rayleigh time step, and the simulation was performed for a total of 2.5 s^[17,18].

Figure 10 shows the effect of two different structures of the central chute of the big ridge on soil casting in a tangent line by the scraper soil lifter. When using the traditional type of central chute at the big ridge with front baffle, the soil would collide with the front baffle, so that some soil cannot enter the chute and fall, resulting in the uneven distribution of soil belts, and retaining the soil on film surface and avoiding soil at both sides of film from shunting (Figure 10a), causing failure of the construction of seedbed film mulching. The structure of the chute at the center of the big ridge was optimized by removing the front baffle, so that the soil is cast in a “curtain shape” curve into the soil covering enclosure, and form soil belts under the effect of the parallel shunt type soil covering device, as shown in Figure 10b.

Therefore, it is necessary to make a detailed simulation analysis on the operation process of the soil covering device by removing the front baffle of the chute at the center of the big ridge, and to evaluate the operation effect after optimizing the soil covering path. Figures 11a-11i show the dynamic soil elevation, delivery and casting processes in the soil covering device when the device was advancing at 1.10 m/s during time $t = 0.60-4.60$ s.

Since it is necessary to observe soil casting and delivery process of the scraper soil lifter, the simulation needs to be started when the scraper soil lifter elevates soil in a stable working state. Therefore, the EDEM numerical simulation starts from $t=0.60$ s, when the working condition of the soil covering device is close to the real condition, as shown in Figure 11a. When $t=1.10$ s, the soil in the scraper soil lifter is about to be cast in a tangent line into the soil covering device; when $t=1.60$ s, some soil has been shunted. Since small ditches are in vertical distribution, the soil covering path is shorter than that at the center of the big ridge, the four soil belts on ditches are formed first. When $t=2.10$ s, the chutes at both sides and the center of the big ridge gradually produce continuous soil particle flow, and 7 stable soil belts are formed, which meets the agronomic requirements of the full-film double-ditch seedbed with double-width filming. From $t = 2.60-4.60$ s (Figures 11e-11i), the parallel shunt type soil covering device works in a stable state, and the soil amount in the soil belts on the four ditches is uniform. The soil amount in chute at both sides of the big ridge is about 1/2 of that at the center of the big ridge.

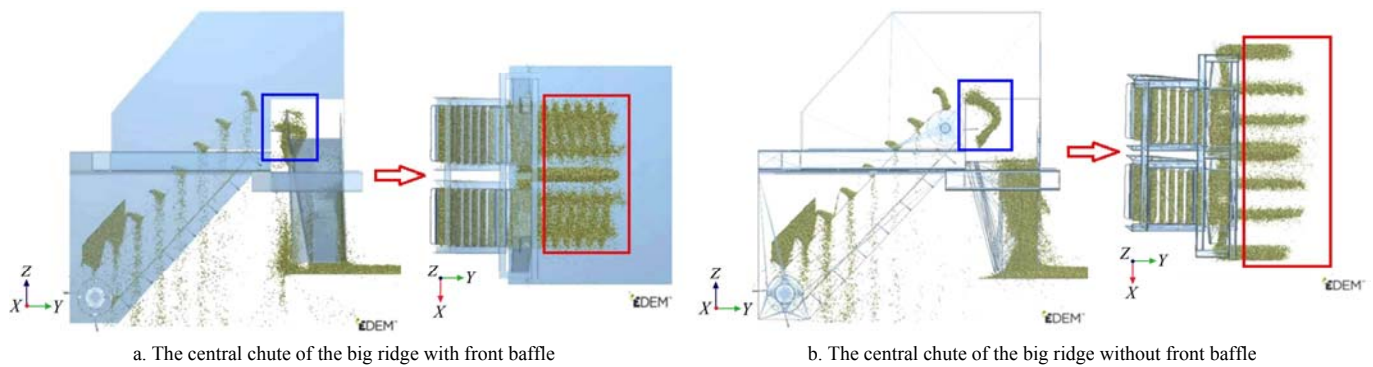

Figure 10 The influence of two structures of the central chute of the big ridge on soil casting in a tangent line

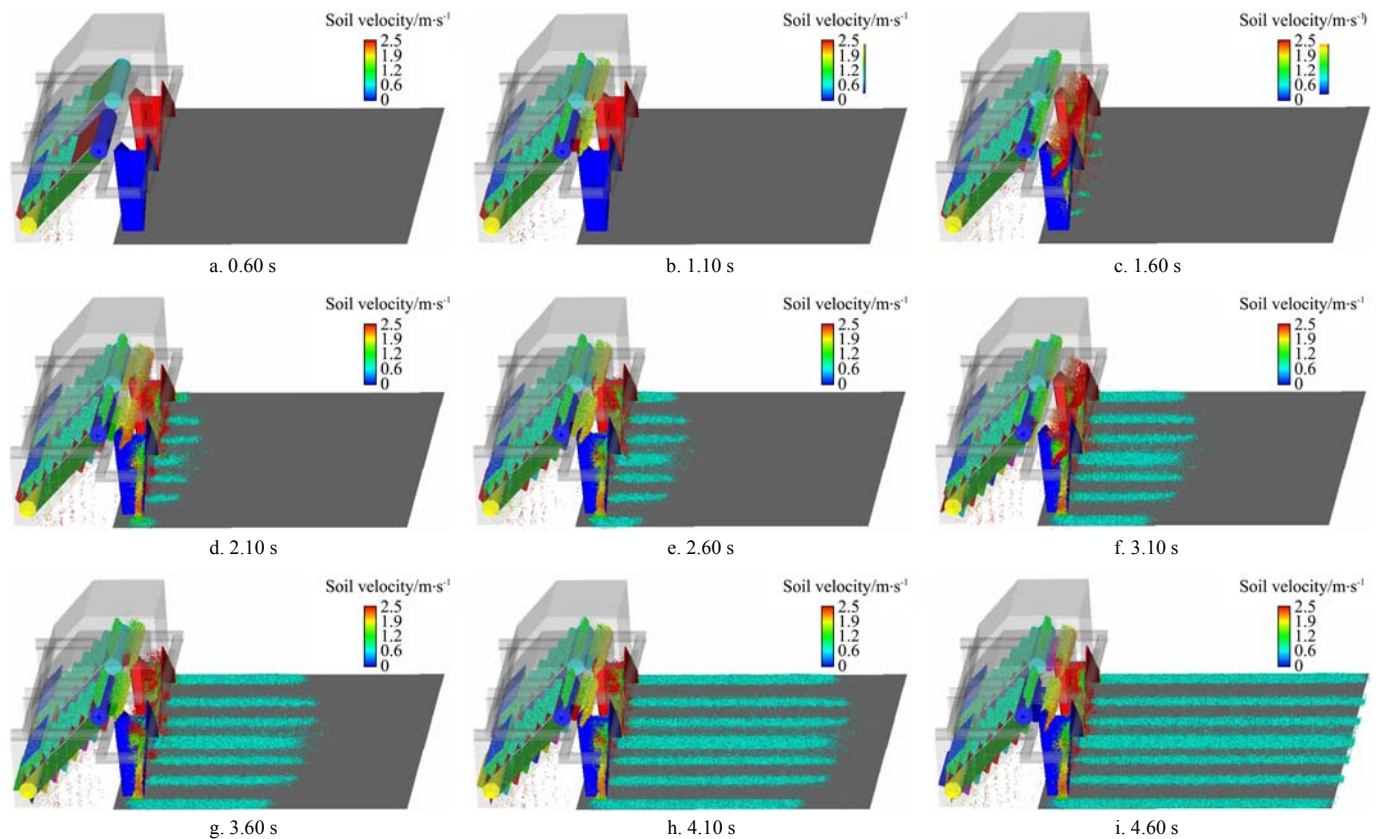

Figure 11 Operation process of the parallel shunt type soil covering device with double-width filming

The simulation analysis of the operation process of the parallel shunt type soil covering device with double-width filming shows that, by improving and optimizing the mechanized soil covering path, the soil particle flow is evenly laid on the seedbed (Figure 12a). Compared with the operation effect of the soil covering device before optimization (Figure 12b)^[4], this kind of soil covering device disturbs less soil, and the width and thickness of soil belts could meet the agronomic requirements, results showed that the device could basically satisfy the double-width filming requirements for a full-film double-ditch seedbed.

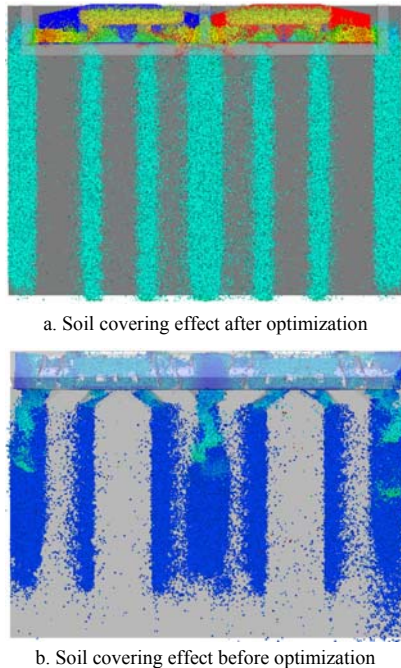

Figure 12 Comparison of soil covering effects in double width filming

5 Field test verification

In order to further verify the operation effect after soil covering path optimization under the agronomic mode of full-film double-ditch with double-width filming, the parallel shunt type soil covering device was installed on the designed full-film double-ditch combined machine with double-width filming by the research group of this study (Figure 13a). The experiment was carried out in the experimental field of Gansu Tao River Tractor Manufacturing Co., Ltd.-Gansu Agricultural University Lintao Dryland Farm Machinery Equipment Test Field. The test materials and test methods are the same as that in the literature [16], and the seedbed construction effect is shown in Figure 13b. In the test process, the qualified rate of the soil covering width on film edge of the seedbed, the qualified rate of soil covering thickness, and the qualified rate of the soil covering width at the center of the big ridge were measured^[4,16].

As shown in Table 1, it can be obtained from the verification test results on the field operation performance that, after the operation of the full-film double-ditch combined machine for double-width filming and soil covering equipped with the parallel shunt type soil covering device, the qualified rate of the film edge soil covering width was 96.1%, an increase of 1.6% compared to that before optimization; the qualified rate of soil covering width at the center of the big ridge was 93.5%, an increase of 1.9% compared to that before optimization; the qualified rate of the soil covering thickness was 97.7%, an increase of 0.2% compared to that before optimization. The test indicators reached the

requirements of relevant national and industrial standards (all the measured indexes reached more than 90% as qualified), showing that the test results met the requirements on design and actual operation, and the operation effect of the seedbed soil covering was obviously improved compared with that before optimizing the soil covering path.



a. Field performance test of combined machine



b. Construction effect of the full-film double-ditch seedbed with double-width filming

Figure 13 Verification test on the field operation performance

Table 1 Field performance test results of combined machine

Test indexes	Before optimization	After optimization	Standard value
Qualified rate of soil covering width at film edge/%	94.5	96.1	≥90
Qualified rate of soil covering width at the center of the big ridge/%	91.6	93.5	≥90
Qualified rate of soil covering thickness on seedbed/%	97.5	97.7	≥90

It can be seen from the construction effect of the full-film double-ditch and double-width filming seedbed shown in Figure 13b that the distribution of the soil-covered belts at each position of the seedbed is basically consistent with the simulation analysis result (Figure 12a), indicating that the related parameters in the numerical simulation of the double-width filming process were accurate and the established discrete element model was reasonable. During the test, it was found that the parallel shunt type soil covering device greatly improved the efficiency of soil covering of the mechanized seedbed. By using the scraper soil lifter to cast soil in a tangent line into corresponding soil bins, under the guiding effect of the chute, 7 uniform soil belts were formed on the film-mulching seedbed, which could meet the agronomic requirements on double-width filming of full-film double-ditch seedbed.

6 Conclusions

1) Under the working conditions of different parameters of the helical push-type soil covering device for double-width filming, the dynamic soil covering characteristics and soil covering uniformity of the device were analyzed, the collaborative and interactive coupling mechanism of the transverse pushing process of the

mulched soil and horizontally two-way helical soil transmission device were revealed, and the main reasons for the influence of different soil covering belts on the change of soil particle number distribution.

2) Based on the mode of full-film double-ditch with double-width filming, the mechanized soil covering path was optimized. In order to further reduce the disturbance on mulched soil by two-way helical pushing, a kind of parallel shunt type soil covering device with double-width filming was designed, then a discrete element method was adopted to make simulation analysis of the parallel shunt type soil covering device with double-width filming.

3) Field verification tests showed that after the operation of the full-film double-ditch combined machine for double-width filming and soil covering equipped with the parallel shunt type soil covering device, the qualified rate of the film edge soil covering width was 96.1%, an increase of 1.6% compared to that before optimization; the qualified rate of soil covering width at the center of the big ridge was 93.5%, an increase of 1.9% compared to that before optimization; the qualified rate of the soil covering thickness was 97.7%, an increase of 0.2% compared to that before optimization. The test indicators reached the requirements of relevant national and industrial standards (all the measured indexes $\geq 90\%$), showing that the test results met the design requirements, and the working conditions of verification tests were consistent with the simulation results.

Acknowledgements

The authors acknowledge that this work was financially supported by the National Natural Science Foundation of China (Grant No. 52065005; No. 51775115), Outstanding Youth Foundation of Gansu Province (Grant No. 20JR10RA560), Natural Science Foundation of Gansu Province (Grant No. 20JR5RA029), Research Program Sponsored by Gansu Provincial Key Laboratory of Aridland Crop Science, Gansu Agricultural University (Grant No. GSCS-2020-01).

[References]

- [1] Dai F, Zhao W Y, Zhang F W, Ma H J, Xin S L, Ma M Y. Research progress analysis of furrow sowing with whole plastic-film mulching on double ridges technology and machine in northwest rainfed area. *Transactions of the CSAM*, 2019; 50(5): 1–16. (in Chinese)
- [2] Zhou L M, Jin S L, Liu C A, Xiong Y C, Si J T, Li X G, et al. Ridge-furrow and plastic-mulching tillage enhances maize-soil interactions: opportunities and challenges in a semiarid agroecosystem. *Field Crops Research*, 2012; 126: 181–188.
- [3] Gan Y T, Siddique K H, Turner N C, Li X G, Niu J Y, Yang C, et al. Chapter seven-ridge-furrow mulching systems-an innovative technique for boosting crop productivity in semiarid rain-fed environments. *Advances in Agronomy*, 2013; 118(1): 429–476.
- [4] Dai F, Zhang S L, Song X F, Zhao W Y, Ma H J, Zhang F W. Design and test of combined operation machine for double width filming and covering soil on double ridges. *Transactions of the CSAM*, 2020; 51(5): 108–117. (in Chinese)
- [5] Niu Q, Wang S G, Chen X G. Design of rice planter with plastic film mulched drip irrigation. *Transactions of the CSAM*, 2016; 47(S1): 90–95, 102. (in Chinese)
- [6] Kang J M, Wang S G, Chen X G, Yan L M. Design and experiment of synchronous laying membrane and irrigation pipe for dry-land rice planter. *Journal of China Agricultural University*, 2016; 21(2): 124–131. (in Chinese)
- [7] Zhao J L, Shang S Q, Hua W, Wang D W, Yang R B. Design of the 2BFD-2C peanut membrane planter. *Journal of Agricultural Mechanization Research*, 2013; 35(2): 51–55. (in Chinese)
- [8] Lü X L, Hu Z C, Liu M J, Yu X T, Zhang H J. Design and experiment of the 2BQHM-2 peanut mulching film and punching planter. *Journal of South China Agricultural University*, 2015; 36(1): 96–100. (in Chinese)
- [9] Zhao L J, He D, Zhou F J. Parameter optimization and test on soil-covering mechanism of 2BF-1400 rice mulching film seeder machine. *Transactions of the CSAE*, 2015; 31(11): 21–26. (in Chinese)
- [10] Li W M, Cao W B, Gu W J, Chen M N, Jing J J. The design of mulching film machine used after transplanting. *Journal of Agricultural Mechanization Research*, 2014; 36(1): 152–154, 164. (in Chinese)
- [11] Cui Y C, Jia L G, Chen W, Zheng D H, Du W L, Fan M S. Design and test of the Rain-fed potato planter with micro-ridge and plastic film mulching. *Journal of Agricultural Mechanization Research*, 2016; 38(2): 62–66. (in Chinese)
- [12] Yang W W, Luo X W, Wang Z M, Zhang M H, Zeng S, Zang Y. Design and experiment of track filling assembly mounted on wheeled-tractor for paddy fields. *Transactions of the CSAE*, 2016; 32(16): 26–31. (in Chinese)
- [13] Dai F, Guo W J, Song X F, Shi R J, Zhao W Y, Zhang F W. Design and test of crosswise belt type whole plastic-film ridging-mulching corn seeder on double ridges. *Int J Agric & Biol Eng*, 2019; 12(4): 88–96.
- [14] Ucgul M, Fielke J M, Saunders C. Comparison of the discrete element and finite element methods to model the interaction of soil and tool cutting edge. *Biosystems Engineering*, 2018; 169: 199–208.
- [15] Wang X Z, Zhang S, Pan H B, Zheng Z Q, Huang YX, Zhu RX. Effect of soil particle size on soil-subsoiler interactions using the discrete element method simulations. *Biosystems Engineering*, 2019; 182: 138–150.
- [16] Dai F, Zhao W Y, Shi R J, Zhang F W, Ma H J, Ma M Y. Design and experiment of operation machine for filming and girdle covering on double ridges. *Transactions of the CSAM*, 2019; 50(6): 130–139. (in Chinese)
- [17] Tamas K. The role of bond and damping in the discrete element model of soil-sweep interaction. *Biosystems Engineering*, 2018; 169: 57–70.
- [18] Barr J B, Ucgul M, Desbiolles J M A, Fielke J M. Simulating the effect of rake angle on narrow opener performance with the discrete element method. *Biosystems Engineering*, 2018; 171: 1–15.