

Design and test of fault monitoring system for corn precision planter

Qi Jiangtao¹, Jia Honglei^{1*}, Li Yang¹, Yu Haibo¹, Liu Xinhui², Lan Yubin³,
Feng Xianzhen¹, Yang Yongxi¹

(1. Key Laboratory of Bionic Engineering (Ministry of Education), Jilin University, Changchun 130022, China;

2. College of Mechanical Science and Engineering, Jilin University, Changchun 130022, China;

3. College of Engineering, South China Agricultural University, Guangzhou 510642, China)

Abstract: With the growing demand and working complexity of corn precision planter, it becomes more important to monitor the working performance through intelligent systems. A new fault monitoring system for corn precision planters was designed and tested. This system consisted of the information acquisition module, controller module, alarm module, input module and display module. A capacitive sensor was utilized to monitor the seed flow without changing the track of a precision planter. This system can monitor the whole sowing process of a seed-metering device in real-time. The sowing status, fault type and fault location can be displayed on liquid crystal display (LCD). Warning light on the LCD reminds the operator of abnormal conditions. Bench tests and field tests showed that the minimum monitoring accuracies of missing sowing and total sowing number were 92.11% and 94.28%, respectively, and the seed level sensor and the opener sensor worked well. This system can accurately prompt the seed-metering mechanism in real-time.

Keywords: corn, precision planter, fault monitoring system, precision agriculture, capacitive sensor, missing sowing

DOI: 10.3965/ijabe.20150806.1968

Citation: Qi J T, Jia H L, Li Y, Yu H B, Liu X H, Lan Y B, et al. Design and test of fault monitoring system for corn precision planter. *Int J Agric & Biol Eng*, 2015; 8(6): 13–19.

1 Introduction

Precision planting with the advantage of saving quality seeds can improve crop yield and solve the

problem of grain shortage^[1]. In conservation agriculture, land surfaces are covered by numerous corn stalks and stubbles^[2-4], and ground wheels skid to block seed drop pipes. However, after sowing is completed with these coverings, the sowing status is hardly detectable. Missing sowing or box emptying, if not discovered in time, will cause huge losses^[5,6]. The status of working machine is a basis for farmers to inspect the working quality of precision planting machinery and also a reference for them to manage agriculture machinery^[7].

Currently, the studies about precision planting monitoring (PPM) systems are mainly focused on missing sowing, multiple-sowing, or design of missing sowing sensors^[8]. Photosensors are widely used in the existing PPM systems^[9]. Okopnik devised a system with the infrared sensor to determine the distance between seeds and the system was tested in the laboratory^[9]. Xia et al.^[10] established a PPM system on the platform of Laboratory Virtual Instrument Engineering Workbench (LabVIEW). The main performance index of seed

Receive date: 2015-05-21 **Accept date:** 2015-11-17

Authors: **Qi Jiangtao**, PhD, Lecturer. Major in agricultural electrification and automation. Email: qijiangtao@jlu.edu.cn;

Li Yang, graduate student, Major in agricultural electrification and automation. Email: liyong-91@qq.com; **Yu Haibo**, graduate student, Major in agricultural electrification and automation. Email: 991459453@qq.com;

Liu Xinhui, PhD, Professor, Major in electro-hydraulic control of mechanical engineering. Email: liuxh@jlu.edu.cn;

Lan Yubin, PhD, Professor, Major in agricultural electrification and automation. Email: ylan@scau.edu.cn;

Feng Xianzhen, graduate student, Major in agricultural electrification and automation. Email: fengxianzhen2012@126.com;

Yang Yongxi, graduate student, Major in agricultural electrification and automation. Email: 316559249@qq.com.

***Corresponding author:** **Jia Honglei**, PhD, Professor, Major in bionic intelligent agricultural machinery and conservation tillage technology. Key Laboratory of Bionic Engineering (Ministry of Education), Jilin University, 130022, China. Tel: +86-13504308621, Email: jiah1@vip.163.com.

metering devices was determined through laboratory bench tests^[10]. Gong et al.^[11] refitted the inner-filling-typed metering device by installing a photosensor for inspection of missing sowing, but the application scope of this method should be broadened.

With the development of computer technology image processing and machine vision technologies were also used in sowing performance tests^[12-15], but the technological application was limited by the bad field environment.

In recent years, capacitive sensors, piezoelectric sensors and other new types were also applied into planting monitoring. Zhou et al.^[16] developed a capacitive sensor that could monitor the wheat flow rate by building a relationship between sensor capacitance and flow rate, which provided technical support for variable sowing. Zhou et al.^[17] also analyzed the kinematic properties based on capacitance signal acquisition and the sowing performance monitoring method. At the bottom of the meter, Huang et al.^[18] mounted a polyvinylidene fluoride (PVDF) piezoelectric film sensor, which generated a pulse signal when hit by a seed. However, system installation will change the seed track, thus reducing the sowing quality.

The complex and changeable field environment significantly affects the stability of metering mechanism and monitoring system. Analysis of fault types in the metering mechanism of planters showed that the faults can be caused by stop of a seed-metering wheel, much slower actual speed of seed-metering wheels than the theoretical speed, seed-box emptying and opener blocking, which can improve the sowing quality.

In this study, a PPM system from the perspective of fault part diagnosis in the metering mechanism. This study provides technical support for PPM.

2 System functions and working principle

2.1 System functions

This PPM system aims to detect the type and location of faults in a precision planter. To meet above analysis, the following four items into the functions of this PPM system.

(1) The fault location monitoring module for the seed metering mechanism will monitor seed level of the seed

box, seed flow and opener block state. The monitoring system sends an alarm once a location fault occurs, and the type and location of the fault will be displayed on the liquid crystal display (LCD).

(2) The working parameters of the monitoring module for a precision planter include actual seed spacing, number of missing sowing, number of multiple-sowing, total sowing number and ground speed. When something wrong occurs to the seeder, the controller sends an alarm to inform the operator.

(3) Friendly human-computer interaction. To simplify the use of this system, we need a friendly human-computer interaction method. A matrix keyboard and an LCD module are used as the input and output devices, respectively.

2.2 Working principle

In the whole sowing process, a corn seed drops from the seed-metering mechanism, falls into the seed drop pipe, and drops on the seed bed after the opener ditches the soil. To monitor the sowing process completely, sensors have been installed into this system at the seed box, the seed drop pipe and the opener separately. The monitor sensors for seed box level, seed flow, and opener block are installed at the bottom of the seed box, on the upper part of the seed drop pipe, and at the top of the opener, respectively (Figure 1).

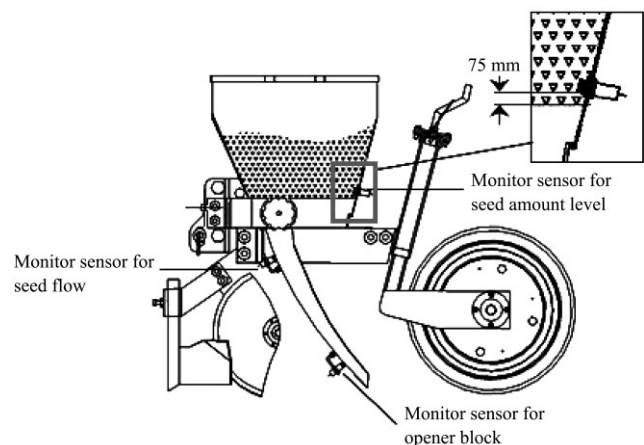

Figure 1 The mounting locations of the sensors

These sensors monitor the working states of the corresponding parts, and transport signals to the controller module. The controller module monitors the fault types and fault locations by utilizing different subroutines. The specific monitoring process is described as Figure 2.

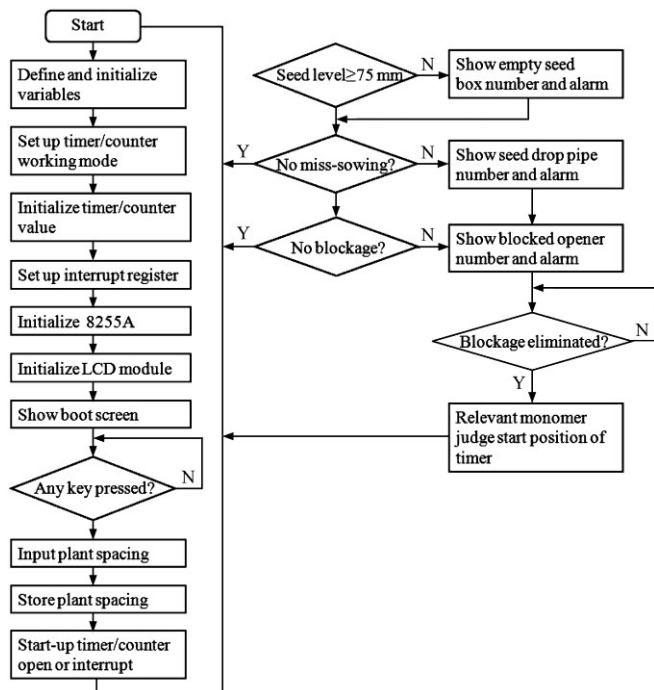

Figure 2 Flowchart of subprogram for judging empty seed box

2.2.1 Monitoring of seed box level

The monitor sensor for seed box level is installed at the bottom of the seed box. According to the experimental data, when the seed level is less than 75 mm, the sensor sends a signal indicating the seed level is low and requires to add seeds. Otherwise, when the seed level is more than 75 mm, the sensor indicates the seed amount meets the sowing needs. The judgement of empty seed box subprogram is described as Figure 3.

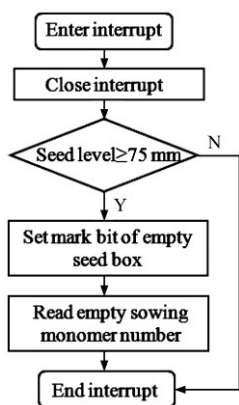

Figure 3 Flowchart of judging empty seed box subprogram

2.2.2 Monitoring of seed flow

When seeds drop successively and intermittently through the sensor, a pulse signal with amplitude of 12 VDC is generated. Before transmission to the counter chip, this signal is converted to a Transistor-Transistor Logic (TTL) signal via the signal conditioning circuit.

The encoder located on the rear wheel is selected as a displacement sensor of the tractor. The encoder and the

rear wheel rotate at the same angular velocity. Each revolution of the encoder generates a 3600-pulse signal.

The counter chip marks the time of each seed. If the number of encoder-generated pulses between two seeds is n_i , the travel distance X_i or the seed spacing can be calculated as follows:

$$X_i = \frac{n_i}{N} \cdot \pi d \tag{1}$$

where, n_i is the number of pulses of the Hall element in Δt ; N is the number of pulses of the driving wheel ($N=3600$ here); d is diameter of the driving wheel ($d=1.57$ m).

According to GBT/6973-2005 Testing Methods of Single Seed Drills (Precision Drills), X_i between 0 and $0.5 X_r$ (X_r is theoretical seed spacing) is defined as multiple-sowing, X_i between $0.5 X_r$ and $1.5 X_r$ as normal, and $X_i > 1.5 X_r$ as missing sowing^[19]:

$$0.5 X_r \leq X_i \leq 1.5 X_r \text{ (normal-sowing)} \tag{2}$$

$$X_i > 1.5 X_r \text{ (missing sowing)} \tag{3}$$

$$X_i \leq 0.5 X_r \text{ (multiple-sowing)} \tag{4}$$

The system controller calculates the numbers of missing sowing, multiple-sowing and normal-sowing separately. Flow rate subprogram and flowchart of missing sowing subprogram are shown in Figures 4 and 5, respectively.

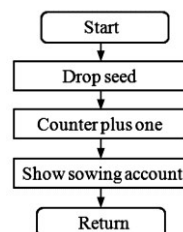

Figure 4 Flowchart of flow rate subprogram

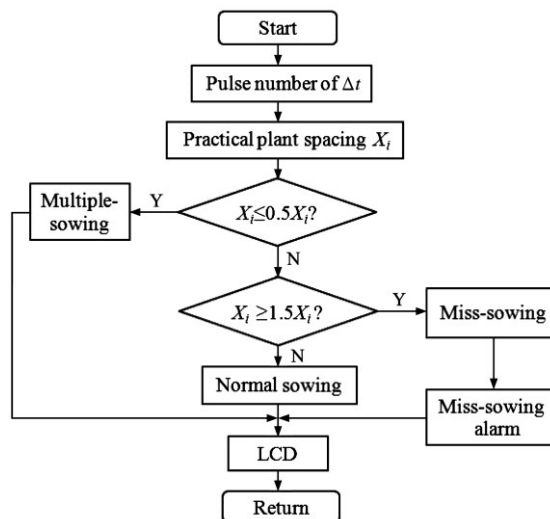

Figure 5 Flowchart of missing sowing subprogram

2.2.3 Monitoring of opener block state

The opener block sensor has been installed on the upper part of the opener. The sensor normally outputs a low level signal. The sensor generates a pulse signal when the seed passes through in a normal sowing progress, as well as seed or soil bounce. Opener block judgement subprogram is shown in Figure 6. Once the opener is blocked, the sensor will generate a continuous high-level signal.

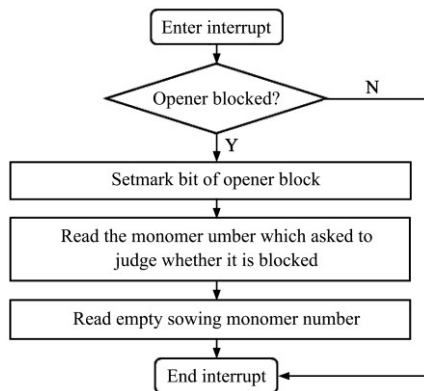

Figure 6 Flowchart of opener block judgement subprogram

3 System hardware structure

The system hardware includes an information acquisition module (e.g. ground speed acquisition, seed flow acquisition), a controller module (consisting of a single-chip microcomputer), an alarm module, an input module and a display module (Figure 7).

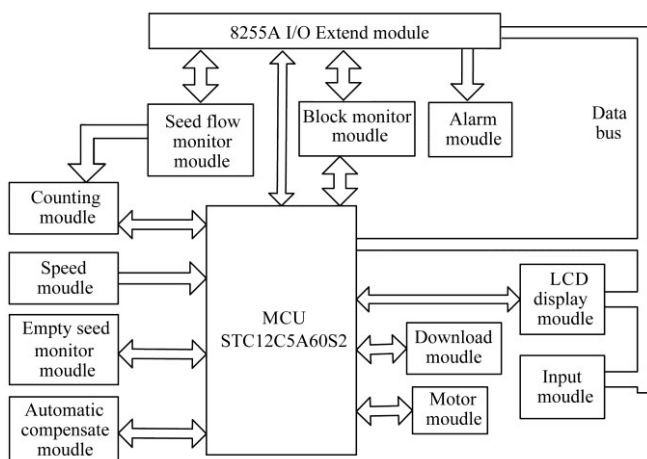

Figure 7 Diagram of the hardware structure

3.1 Information acquisition module

3.1.1 Monitoring sensor unit

Each sowing unit has been installed with a seed box level sensor, a seed drop pipe sensor and an opener sensor. All capacitive sensors are TAP-30D40N1-D3 model with diameter of 30 mm and sensing distance of 0-30 mm.

The details are shown in Table 1. The capacitive sensor, a non-contact sensor, can directly monitor the seed flow. The capacitive sensor has two coaxial metal electrodes inside, which form a capacitor. When the measured object (metal or nonmetal) approaches the sensor surface, it will enter the electric field generated by the two electrodes, thus changing the electric capacity of the capacitor. The output circuit detects the change and generates an output signal.

Table 1 Main specifications of TAP-30D40N1-D3 capacitive sensor

Type	Parameter
Operating voltage/V	10-30
Max. load current/mA	300
Switching frequency/Hz	100
Response time/ms	1.5
Output voltage/V	V _{cc}

The monitoring system designed here can simultaneously monitor the working states of 6 sowing units. Each unit requires a counter to monitor the seed flow. The counter used here is a count chip 74LS590 containing storage register. Two 74LS590 chips compose a 16 bit counter. The 74LS590 chip emits tri-state outputs (high, low and high impedance), so it can be connected directly with the system data bus, thus reducing the system demand for counter resources.

3.1.2 Ground speed acquisition module

The tractor displacement is acquired from the PHB8-3600-G05L encoder. The controller gains the number of pulses every unit time, and then calculates the working velocity v and the working area S_i of the tractor:

$$v = \frac{7.2\pi R p}{N} \tag{5}$$

where, v is ground speed of tractor, km/h; N is the number of pulses per revolution ($N=3600$ here); p is the number of pulses per second; R is the radius of the rear wheel, m.

$$s_i = \frac{2\pi n R d}{N} \tag{6}$$

where, n is total number of pulses since the start-up of work; d is width of the seeder, m.

3.2 Controller module

The monitoring system needs an appropriate controller, which is very important. To achieve high performance, we selected an STC12C5A60S2 single-chip

microcomputer as the controller. This system needs many I/Os in order to meet this requirement. An 8255A chip is used to extend system I/O resources.

3.3 Human-computer interaction module

In the working process, if fault (e.g. missing sowing, opener blocking and box emptying) is detected in one or several rows, the alarm module emits an alarm signal from the speaker, and displays the fault type and location on the LCD panel.

The keyboard and the display panel are important ways for the user to interact with the monitoring system. The JM160128BLCD module has been used as the display module in this system.

The system utilizes a 4×4 matrix keyboard to input information. The keyboard has 10 number buttons (0-9), 4 direction buttons (up, down, left and right), a “Confirm” button and a “Back” button.

4 Bench tests and field tests

4.1 Bench tests

Monitoring accuracies in missing sowing, multiple-sowing, number of qualified sowing and number of total sowing are significant indicators to evaluate the system performance. Bench tests and field tests are designed by reference to GBT/6973-2005, with the following division methods:

$$n_1 = \sum n_i \{X_i \in (0, 0.5X_r]\} \tag{7}$$

$$n_2 = \sum n_i \{X_i \in (0.5X_r, 1.5X_r]\} \tag{8}$$

$$n_3 = \sum n_i \{X_i \in (1.5X_r, \infty)\} \tag{9}$$

$$N = n_1 + n_2 + n_3 \tag{10}$$

where, n_i is frequency of seeds in each section, Hz; n_1 is number of repeated sowing seeds; n_2 is number of

qualified seeds; n_3 is number of missing sowing; N is total number of seeds.

The bench tests were carried out at the Agricultural Engineering Laboratory of Jilin University. A JPS-12 seed-metering mechanism performance test bench (Figure 8) was used for mechanical sowing and pneumatic sowing experiments. The measuring errors of shaft speed and seed spacing are less than 0.5% and less than or equal to 2%, respectively.



Figure 8 Bench test

The normal plant spacing of corns in Northeast China is 260 mm. The socket of the seed metering mechanism bench has 10 holes. To guarantee the plant spacing, we set the machine working speeds at 3.12 km/h and 7.80 km/h, corresponding to the sowing shaft speeds of 20 r/min and 50 r/min, respectively. The shaft speeds were set at 20 r/min, 25 r/min, 30 r/min, 35 r/min, 40 r/min, 45 r/min and 50 r/min, respectively. In each test, the fault monitoring system monitored the sowing process in real time. The monitored indicators include the numbers of qualified sowing, missing sowing, multiple-sowing, and total sowing. The actual seed spacing is guaranteed by the image processing system in the bench, and 500 seeds are chosen as the test samples. Results are shown in Table 2.

Table 2 Results of bench tests

No.	Shaft speed	Actual seed number				Seed number by the monitoring system				Accuracy/%			
		Missing	Multiples	Normal	Total	Missing	Multiples	Normal	Total	Missing	Multiples	Normal	Total
1	20	29	22	449	500	28	17	446	492	96.55	77.27	99.33	98.40
2	25	27	24	449	500	26	19	447	492	96.30	79.17	99.55	98.40
3	30	33	20	447	500	31	13	447	491	93.94	65.00	100.00	98.20
4	35	28	23	449	500	26	16	450	492	92.86	69.57	99.78	98.40
5	40	38	19	443	500	35	15	441	491	92.11	78.95	99.55	98.20
6	45	37	19	444	500	35	15	440	490	94.59	78.95	99.10	98.00
7	50	43	17	440	500	40	12	439	491	93.02	70.59	99.77	98.20
Max accuracy	—	—	—	—	—	—	—	—	—	92.11	65.00	99.10	98.00
Min accuracy	—	—	—	—	—	—	—	—	—	96.55	79.17	100.00	98.40
Ave accuracy	—	—	—	—	—	—	—	—	—	94.20	74.21	99.58	98.26

4.2 Field tests

The field tests were carried out in the Agriculture Experimental Center of Jilin University (Figure 9). The monitoring system was installed on a 2BGH-6 inter-row tillage seeder and worked at a velocity of 4.00 km/h. The water contents at soil depth of 0-0.1 m, 0.1-0.2 m, 0.2-0.3 m and 0.3-0.4 m are 21.3%, 24.3%, 22.5% and 22.8%, respectively. To count the number of seeds facilitated, the seeder dropped the seeds on the loose surface of soil without soil covering. We measured the actual planting performance (Figure 10) and compared with the results of the monitoring system (Table 3).

The seed level and blocking condition were qualitatively judged. In the field tests, 50 tests were carried out to verify the performances of the seed level sensor and the opener sensor. Results showed the monitoring system would alarm and display the fault type and fault location when the seed level is below the safe line or when the operator blocks the opener.



Figure 9 Field tests



Figure 10 Measurement of the distance of seeds

Table 3 Results of field tests

No.	Seed number manually counted				Seed number counted by the monitoring system				Accuracy/%			
	Missing	Multiples	Normal	Total	Missing	Multiples	Normal	Total	Missing	Multiples	Normal	Total
1	17	10	268	295	16	8	264	288	94.12	80.00	98.51	97.63
2	16	7	270	293	15	6	265	286	93.75	85.71	98.15	97.61
3	19	6	273	298	18	4	263	285	94.74	66.67	96.34	95.64
4	15	8	269	292	15	6	260	281	100.00	75.00	96.65	96.23
5	15	9	273	297	14	7	259	280	93.33	77.78	94.87	94.28
Max accuracy	—	—	—	—	—	—	—	—	93.33	66.67	94.87	94.28
Min accuracy	—	—	—	—	—	—	—	—	100.00	85.71	98.51	97.63
Ave accuracy	—	—	—	—	—	—	—	—	95.19	77.03	96.90	96.28

4.3 Result analysis

The minimum monitoring accuracies (MMAs) in numbers of missing sowing, multiple-sowing, qualified sowing and total sowing are 92.11%, 65.00%, 99.10% and 98.00% in the bench tests, respectively, and are 93.33%, 66.67%, 94.87% and 94.28% in the field tests, respectively. The MMA of missing sowing in the two situations is 92.11%, indicated the system can well monitor the missing sowing of the seed-metering mechanism. The MMA of total sowing number (94.28%) is also acceptable for monitoring of the seed-metering mechanism. Thus, this system can accurately determine the total number of seeds.

However, the MMA of multiple-sowing is only

65.00%. According to analysis, when two seeds fall through the sensor monitoring area, the sensor will give a signal. Unfortunately, the monitoring system failed to detect the multiple-sowing. Therefore, more research is needed to investigate how to improve the monitoring accuracy of multiple-sowing.

5 Conclusions

A fault monitoring system for corn precision seeders was developed. This system used capacitive sensors to monitor seed box level, seed flow condition, and opener block state. Via the capacitive sensors, the system can monitor fault type and fault location of the seed-metering mechanism.

Bench tests and field tests showed the MMAs of missing sowing number and total sowing number are 92.11% and 94.28%, respectively. In the 50 tests, the seed level sensor and the opener sensor worked well. This system can meet the requirement of field working.

Acknowledgments

This paper is supported by two projects: the 12th Five Years National Science and Technology Support Plan Projects of China (No. 2014BAD06B03), the National Natural Science Foundation of China (No. 31401284). Furthermore, we would like to express our special thanks to Professor Ma Chenglin and Associate Professor Guo Li for the kind advice on our paper.

[References]

- [1] Wang M H. Development of Precision Agriculture and Innovation of Engineering Technologies. *Transactions of the CSAE*, 1999; 1: 1–8. (in Chinese with English Abstract)
- [2] Jia H L, Wang L C, Li C S, Tan H J, Ma C L. Combined stalk-stubble breaking and mulching machine. *Soil and Tillage Research*, 2010; 107(1): 42–48.
- [3] Jia H L, Ma C L, Li G Y, Huang D Y, Liu Z C. Combined rototilling-stubble-breaking-planting machine. *Soil and Tillage Research*, 2007; 96(1-2): 73–82.
- [4] He J, Li H W, Wang X Y, A D McHuge, Li W Y, Gao H W. The adoption of annual subsoiling as conservation tillage in dryland maize and wheat cultivation in northern China. *Soil and Tillage Research*, 2007; 7: 493–502.
- [5] Du R C, Gong B C, L N N, Wang C C, Yang Z D, Ma M J. Design and experiment on intelligent fuzzy monitoring system for corn planters. *International Journal of Agricultural & Biological Engineering*, 2013; 6(3): 11–18.
- [6] Zhao B, Kuang L H, Zhang W. Seed and fertilizer intelligent gauging and monitoring system of suction precision seeder. *Transactions of the CSAE*, 2010; 26(2): 147–153. (in Chinese with English Abstract)
- [7] Yu J J, Liao Y T, Cong J L, Yang S, Liao Q X. Simulation analysis and match experiment on negative and positive pressures of pneumatic precision metering device for rapeseed. *International Journal of Agricultural & Biological Engineering*, 2014; 7(3): 1–12.
- [8] Song P, Zhang J X, Li W, Zhang X C, Fang X F. Real-time Monitoring system for accuracy of precision seeder. *Transactions of the CSAM*, 2011; 42(2): 71–74. (in Chinese with English abstract)
- [9] Okopnik D L, Falate R. Usage of the DFRobot RB-DFR-49 Infrared Sensor to detect maize seed passage on a conveyor belt. *Computers & Electronics in Agriculture*, 2014; 102(1): 106–111.
- [10] Xia J F, Zhou Y, Zhang P H. Testing technique of precise seed-metering device based on virtual instrument. *Transactions of the CSAM*, 2009; 40(1): 87–90. (in Chinese with English Abstract)
- [11] Gong L N, Dai Yu H, Jiang J J. Experimental investigation of a new mechanical precision devices for metering device with automatic compensative sowing. *Transactions of the CSAM*, 2008; 39(7): 60–63. (in Chinese with English abstract)
- [12] Karayel D, Wieschoff M, Özmerzi A, Müllerb J. Laboratory measurement of seed drill seed spacing and velocity of fall of seeds using high-speed camera system. *Computers & Electronics in Agriculture*, 2006; 50(2): 89–96.
- [13] Yazgi A, Degirmencioglu A. Optimization of the seed spacing uniformity performance of a vacuum-type precision seeder using response surface methodology. *Biosystems Engineering*, 2007; 97(3): 347–356.
- [14] Navid H, Ebrahimian S, Gassezadeh H R, Mousavinia M J. Laboratory evaluation of seed metering device using image processing method. *Australian Journal of Agricultural Engineering*, 2011; 2: 1–4.
- [15] Zhao Z, Li Y, Chen J, Xu L. Numerical analysis and laboratory testing of seed spacing uniformity performance for vacuum-cylinder precision seeder. *Biosystems Engineering*, 2010; 106(4): 344–351.
- [16] Zhou L, Zhang X, Yuan Y. Design of capacitance seed rate sensor of wheat planter. *Transactions of the CSAE*, 2010; 26(10): 99–103(5). (in Chinese with English abstract)
- [17] Zhou L M, Wang S M, Zhang X C, Yuan Y W, Zhang J N. Seed monitoring system for corn planter based on capacitance signal. *Transactions of the CSAE*, 2012; 28(13): 16–21. (in Chinese with English abstract)
- [18] Huang D Y, Jia H L, Qi Y, Zhu L T, Li H G. sowing monitor system for planter based on polyvinylidene fluoride piezoelectric film. *Transactions of the CSAE*, 2013; 29(23): 15–22. (in Chinese with English abstract)
- [19] Standardization Administration of The People's Republic of China. *GBT/6973-2005 Testing methods of single seed drills (precision drills)*. Beijing: Standards Press of China, 2005.